

Surface Mount Transient Voltage Suppressor

Uni-directional

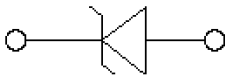
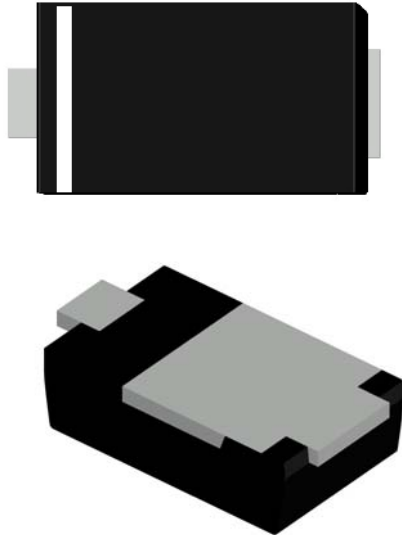

Features

- For surface mounted applications
- Low-profile package
- Ideal for automated placement
- Available in Unidirectional and Bidirectional
- 200 W peak pulse power capability with a 10/1000 μ s waveform
- Low incremental surge resistance, excellent clamping capability
- Very fast response time
- High temperature soldering guaranteed: 260 °C/10 s at terminals
- Meets MSL level 1
- Component in accordance to RoHS

Typical Applications

Use in sensitive electronics protection against voltage transients induced by inductive load switching and lighting on ICs, MOSFET, signal lines of sensor units for consumer, computer, industrial, telecommunication.

Mechanical Date

- **Package:** SOD-123HE
Molding compound meets UL 94 V-0 flammability rating, RoHS-compliant, halogen-free
- **Terminals:** Tin plated leads, solderable per J-STD-002 and JESD22-B102
- **Polarity:** For uni-directional types the band denotes cathode end

■Maximum Ratings (Ta=25°C Unless otherwise specified)

PARAMETER	SYMBOL	UNIT	Conditions	Max
Peak power dissipation ⁽¹⁾ ⁽²⁾ (Fig.1)	P _{PPM}	W	with a 10/1000us waveform	200
Peak pulse current ⁽¹⁾	I _{PPM}	A	with a 10/1000us waveform	(See Next Table)
Power dissipation, on infinite heat sink	P _D	W	TL=75°C	0.4
Peak forward surge current, 8.3 ms single half sine-wave unidirectional only ⁽²⁾	I _{FSM}	A		20
Maximum instantaneous forward voltage	V _F	V	I _F =1A	1.5
Operating junction temperature range	T _J	°C		-55 to +150
Storage temperature range	T _{STG}	°C		-55 to +150
Thermal resistance	R _{θJL}	°C/W	Between junction and lead	30
	R _{θJA}		Between junction and Ambient	80
	R _{θJC}		Between junction and Curve	20

Notes:

(1). Non repetitive current pulse, per Fig2 and derated above TA=25°C per Fig3.

(2). Measured on 8.3 ms single half sine-wave or equivalent square wave, duty cycle = 4 pulses per minute maximum



SMFE SERIES

■ Ordering Information (Example)

PREFERRED P/N	PACKING CODE	UNIT WEIGHT(g)	MINIMUM PACKAGE(pcs)	INNER BOX QUANTITY(pcs)	OUTER CARTON QUANTITY(pcs)	DELIVERY MODE
SMFE SERIES	F1	0.024	3000	24000	96000	7" reel

■ Electrical Characteristics (TA=25°C unless otherwise noted)

Part Number	Marking	Breakdown Voltage $V_{BR}@I_T$			Maximum Reverse Leakage $I_R^{(3)} @ V_{RWM}$ (μA)	Working Peak Reverse Voltage V_{RWM} (V)	Maximum Reverse Surge Current $I_{PP}^{(2)}$ (A)	Maximum Clamping Voltage $V_C @ I_{PP}$ (V)
		Min(V)	Max (V)	$I_T^{(1)}$ (mA)				
SMFE5.0A	5.0A	6.4	7.07	10	400	5	21.74	9.2
SMFE6.0A	6.0A	6.67	7.37	10	400	6	19.42	10.3
SMFE6.5A	6.5A	7.22	7.98	10	250	6.5	17.86	11.2
SMFE7.0A	7.0A	7.78	8.6	10	100	7	16.67	12
SMFE7.5A	7.5A	8.33	9.21	1	50	7.5	15.5	12.9
SMFE8.0A	8.0A	8.89	9.83	1	25	8	14.71	13.6
SMFE8.5A	8.5A	9.44	10.4	1	10	8.5	13.89	14.4
SMFE9.0A	9.0A	10	11.1	1	5	9	12.99	15.4
SMFE10A	10A	11.1	12.3	1	2.5	10	11.76	17
SMFE11A	11A	12.2	13.5	1	2.5	11	10.99	18.2
SMFE12A	12A	13.3	14.7	1	2.5	12	10.05	19.9
SMFE13A	13A	14.4	15.9	1	1	13	9.3	21.5
SMFE14A	14A	15.6	17.2	1	1	14	8.62	23.2
SMFE15A	15A	16.7	18.5	1	1	15	8.2	24.4
SMFE16A	16A	17.8	19.7	1	1	16	7.69	26
SMFE17A	17A	18.9	20.9	1	1	17	7.25	27.6
SMFE18A	18A	20	22.1	1	1	18	6.85	29.2
SMFE19A	19A	21.1	23.3	1	1	19	6.54	30.6
SMFE20A	20A	22.2	24.5	1	1	20	6.17	32.4
SMFE22A	22A	24.4	26.9	1	1	22	5.63	35.5
SMFE24A	24A	26.7	29.5	1	1	24	5.14	38.9
SMFE26A	26A	28.9	31.9	1	1	26	4.75	42.1
SMFE28A	28A	31.1	34.4	1	1	28	4.41	45.4
SMFE30A	30A	33.3	36.8	1	1	30	4.13	48.4



SMFE SERIES

SMFE33A	33A	36.7	40.6	1	1	33	3.75	53.3
SMFE36A	36A	40	44.2	1	1	36	3.44	58.1
SMFE40A	40A	44.4	49.1	1	1	40	3.1	64.5
SMFE43A	43A	47.8	52.8	1	1	43	2.88	69.4
SMFE45A	45A	50	55.3	1	1	45	2.75	72.7
SMFE48A	48A	53.3	58.9	1	1	48	2.58	77.4
SMFE51A	51A	56.7	62.7	1	1	51	2.43	82.4
SMFE54A	54A	60	66.3	1	1	54	2.3	87.1
SMFE58A	58A	64.4	71.2	1	1	58	2.14	93.6
SMFE60A	60A	66.7	73.7	1	1	60	2.07	96.8
SMFE64A	64A	71.1	78.6	1	1	64	1.94	103
SMFE70A	70A	77.8	86	1	1	70	1.77	113
SMFE75A	75A	83.3	92.1	1	1	75	1.65	121
SMFE78A	78A	86.7	95.8	1	1	78	1.59	126
SMFE80A	80A	88.8	97.6	1	1	80	1.55	129
SMFE85A	85A	94.4	104	1	1	85	1.46	137
SMFE90A	90A	100	111	1	1	90	1.37	146
SMFE100A	100A	111	123	1	1	100	1.23	162

Notes:

- (1) $t_p \leq 50\text{ms}$ Pulse test: $t_p \leq 50\text{ms}$.
- (2) Surge current waveform per Fig. 2 and derated per Fig.3.
- (3) For bi-directional types having V_{RWM} of 10 V and less, the I_R limit is doubled.

■ Characteristics(Typical)

FIG1: Peak Pulse Power Rating Curve

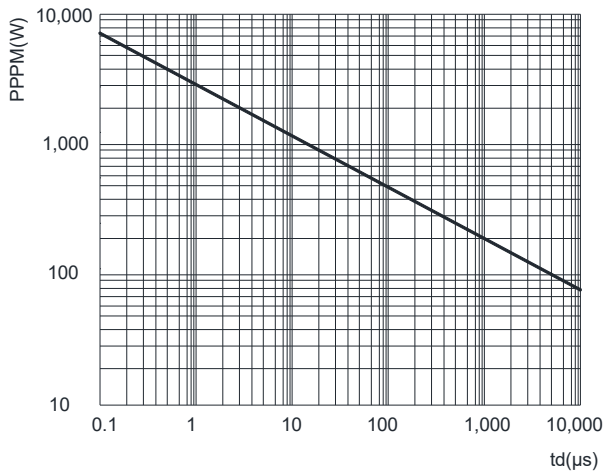

FIG2: Pulse Waveform

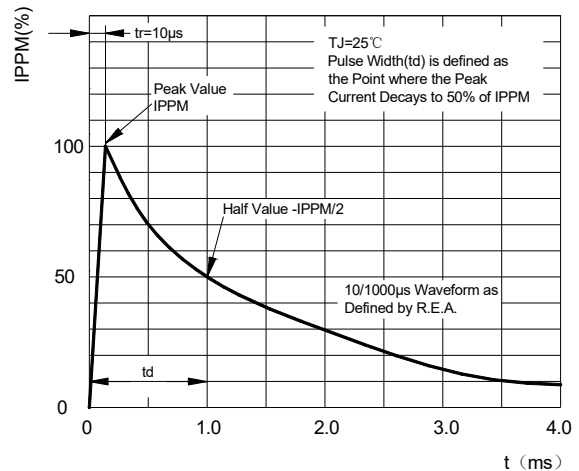

FIG3: Pulse Power or Current vs. Initial Junction Temperature

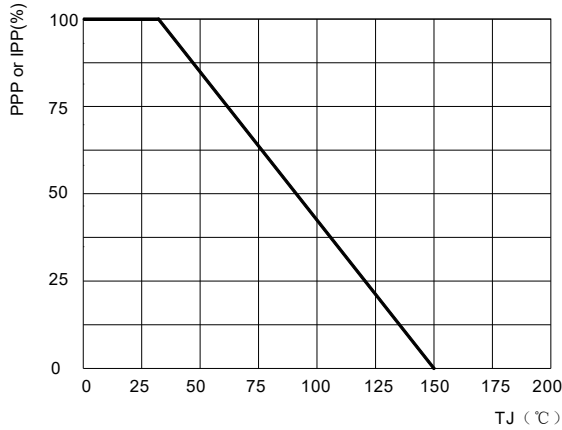
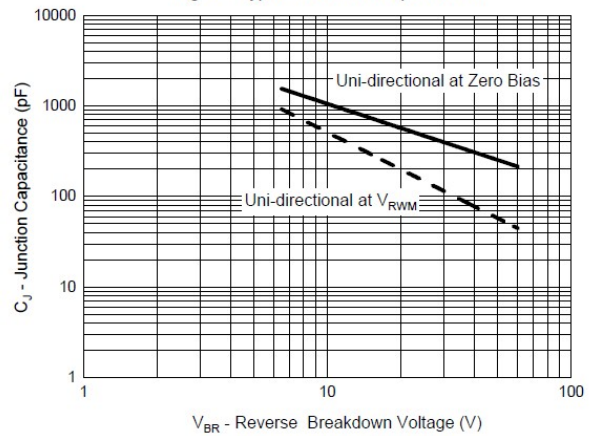
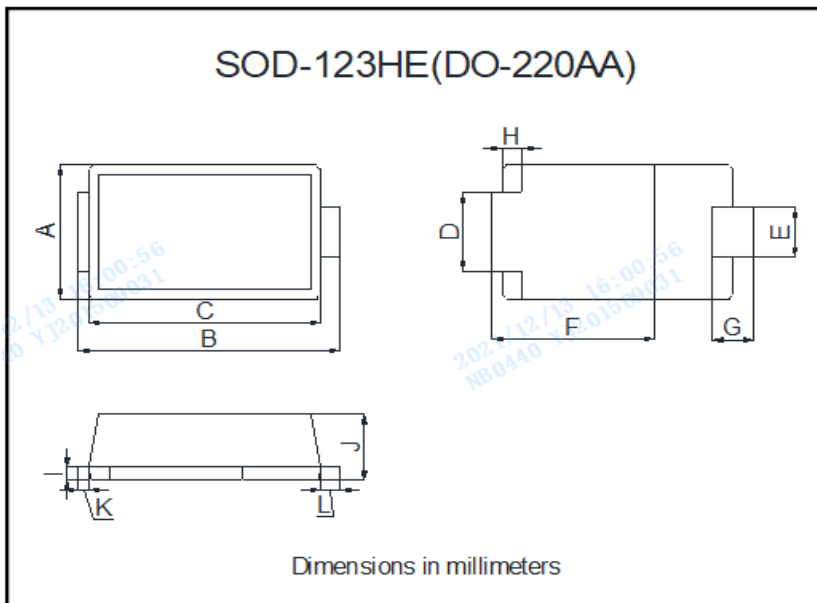

Fig.4 - Typical Junction Capacitance



■ Outline Dimensions



SOD-123HE(DO-220AA)		
Dim	Min	Max
A	1.88	2.18
B	3.70	4.00
C	3.19	3.61
D	1.05	1.35
E	0.61	0.91
F	2.20	2.60
G	0.40	0.80
H	0.30 REF	
I	0.10	0.30
J	0.85	1.15
K	0.00	0.30
L	0.15	0.45

■ Suggested pad layout

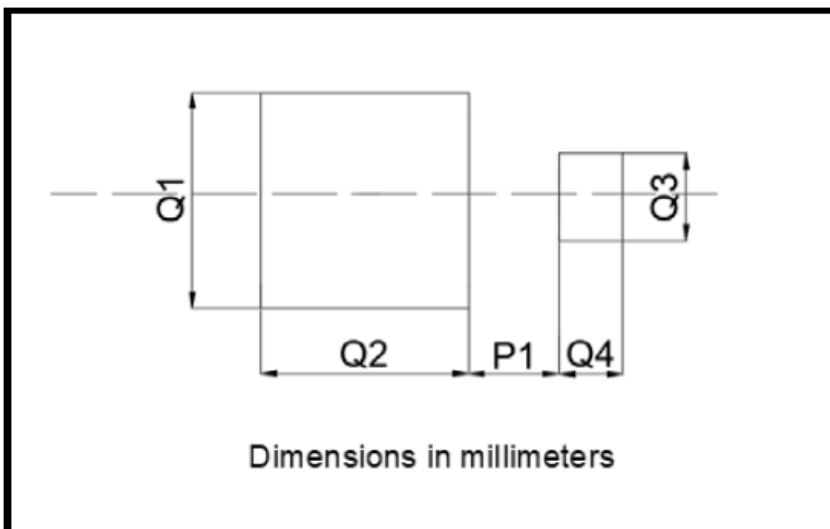

Dim	Millimeters
P1	0.64
Q1	2.54
Q2	2.67
Q3	1.27
Q4	0.76



SMFE SERIES

Disclaimer

The information presented in this document is for reference only. Yangzhou Yangjie Electronic Technology Co., Ltd. reserves the right to make changes without notice for the specification of the products displayed herein to improve reliability, function or design or otherwise.

The product listed herein is designed to be used with ordinary electronic equipment or devices, and not designed to be used with equipment or devices which require high level of reliability and the malfunction of which would directly endanger human life (such as medical instruments, transportation equipment, aerospace machinery, nuclear-reactor controllers, fuel controllers and other safety devices), Yangjie or anyone on its behalf, assumes no responsibility or liability for any damages resulting from such improper use of sale.

This publication supersedes & replaces all information previously supplied. For additional information, please visit our website [http:// www.21yangjie.com](http://www.21yangjie.com) , or consult your nearest Yangjie's sales office for further assistance.