

Ultra-Fast Recovery Rectifier Diodes

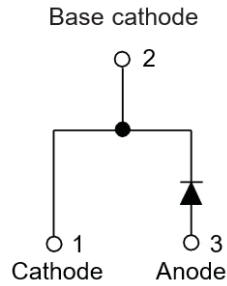

Features

- High frequency operation
- High surge forward current capability
- High purity, high temperature epoxy encapsulation for enhanced mechanical strength and moisture resistance
- Guard ring for enhanced ruggedness and long term reliability
- Solder dip 275 °C max. 7 s, per JESD 22-B106

Typical Applications

Typical applications are in switching power supplies, converters, freewheeling diodes, and reverse battery protection.

Mechanical Data

- **Package:** TO-247AC
Molding compound meets UL 94 V-0 flammability rating, RoHS-compliant
- **Terminals:** Tin plated leads, solderable per J-STD-002 and JESD22-B102
- **Polarity:** As marked

■ Maximum Ratings ($T_j=25^\circ\text{C}$ Unless otherwise specified)

PARAMETER	SYMBOL	UNIT	MURS7560PL
Device marking code			MURS7560PL
Repetitive Peak Reverse Voltage	VRRM	V	600
Average Rectified Output Current @60Hz half sine-wave, R-load, T_c (FIG.1)	I_o	A	75
Surge(Non-repetitive)Forward Current @60Hz half sine-wave, 1 cycle, $T_j=25^\circ\text{C}$	IFSM	A	540
Current Squared Time @ $1\text{ms} \leq t \leq 8.3\text{ms}$ $T_j=25^\circ\text{C}$	I^2t	A^2s .	1210
Storage Temperature	T_{stg}	$^\circ\text{C}$	-55 ~ +175
Junction Temperature	T_j	$^\circ\text{C}$	-55 ~ +175
Typical Junction capacitance @4V, 1MHz	C_j	pF	172



MURS7560PL-B1-W5094HF

■Electrical Characteristics (T_j=25°C Unless otherwise specified)

PARAMETER	SYMBOL	UNIT	TEST CONDITIONS	Min	Typ	Max
instantaneous forward voltage drop per diode	VFM	V	IFM=75.0A Tj=25°C	-	2.1	2.5
			IFM=75.0A Tj=125°C		1.7	2.1
DC reverse current at rated DC blocking voltage per diode	I _{RRM1}	uA	V _{RM} =V _{R_{RM}} Tj=25°C	-	-	5.0
	I _{RRM2}		V _{RM} =V _{R_{RM}} Tj=125°C	-	-	200
Reverse Recovery Time	T _{rr}	ns	I _F =0.5A I _{RM} =1A I _{RR} =0.25A Tj=25°C	-	33	50
			Tj=25°C	-	43.8	
			Tj=125°C	-	53.6	
Peak recovery current	I _{RRM}	A	Tj=25°C	-	11.7	
			Tj=125°C	-	28.1	
Reverse recovery charge	Q _{rr}	nC	Tj=25°C	-	221	
			Tj=125°C	-	1014	

■Thermal Characteristics (T_j=25°C Unless otherwise specified)

PARAMETER	SYMBOL	UNIT	MURS7560PL	
Thermal Resistance	Between junction and case	R _{θJ-C}	°CW	1
	Between junction and Air	R _{θJ-A}	°CW	40

■Ordering Information (Example)

PREFERRED P/N	UNIT WEIGHT(g)	MINIIMUM PACKAGE(pcs)	INNER BOX QUANTITY(pcs)	OUTER CARTON QUANTITY(pcs)	DELIVERY MODE
MURS7560PL	Approximate 6.0	30	360	1800	Tube



■ Characteristics (Typical)

FIG1: I_o - T_c Curve

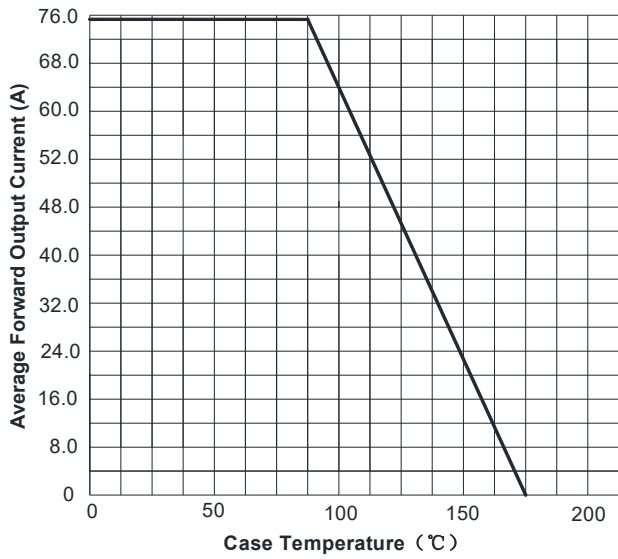

FIG2: Surge Forward Current Capability

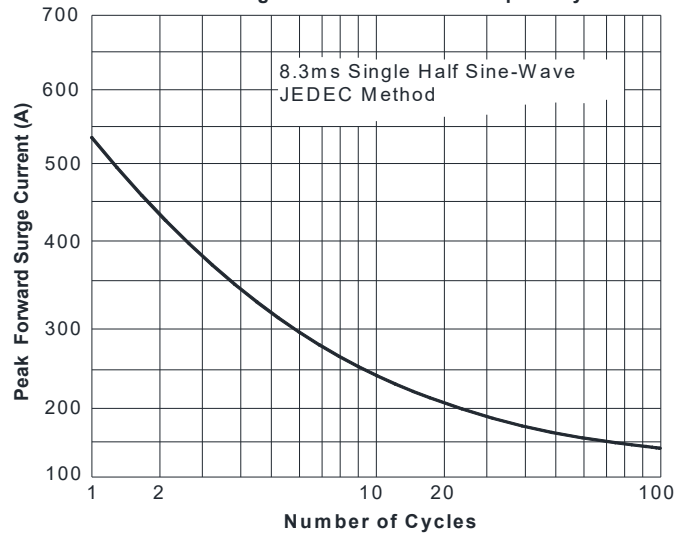

FIG3: Forward Voltage

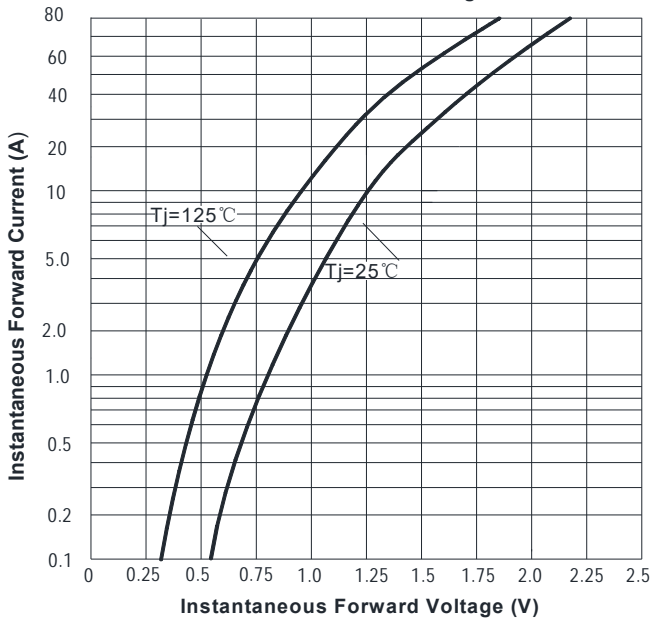

FIG4: Typical Reverse Characteristics

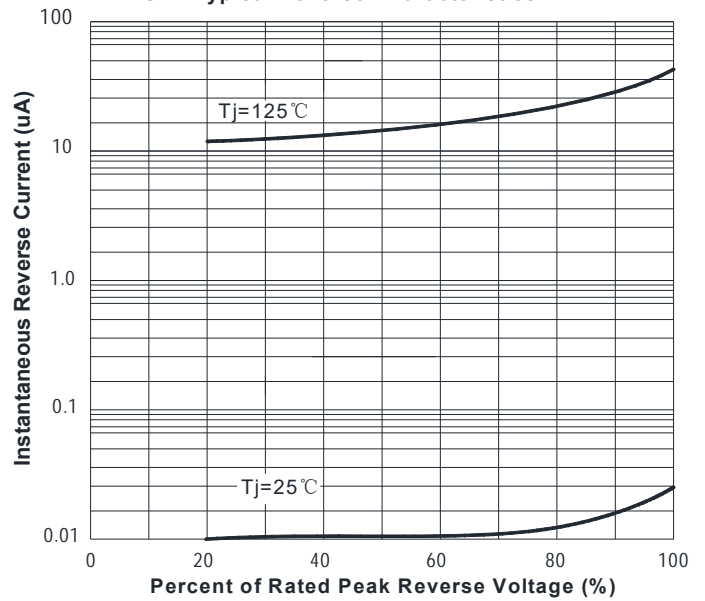
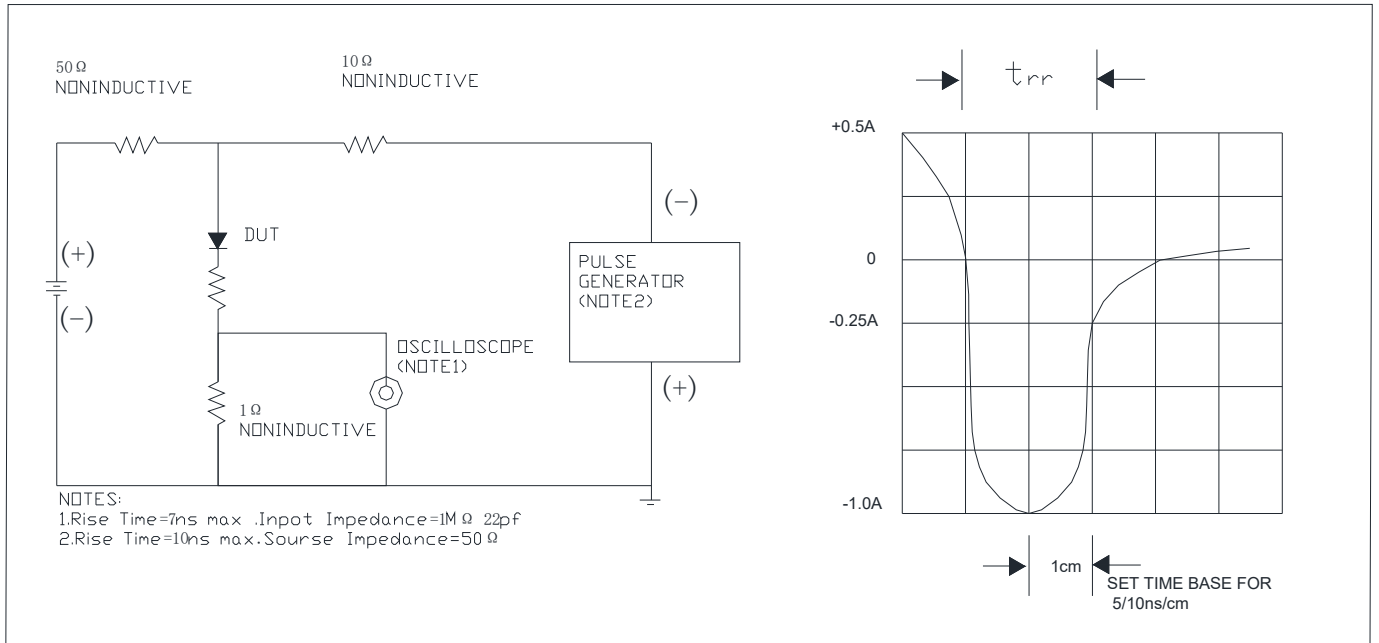
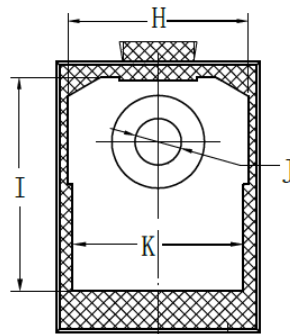
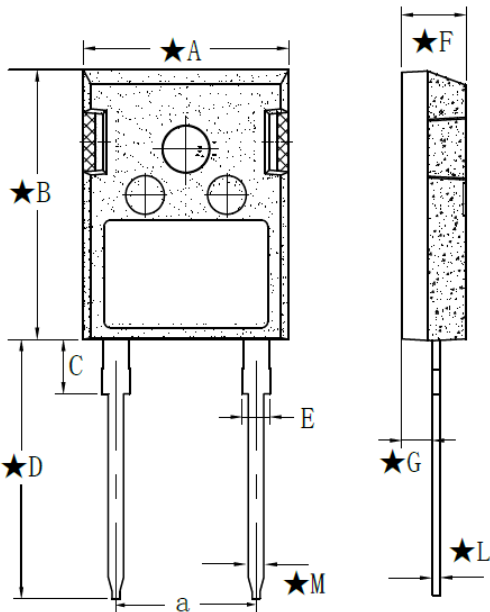

FIG.5 Diagram of circuit and Testing wave form of reverse recovery time



Outline Dimensions



SYMBOL	MIN	MAX
★A	15.72	16.12
★B	20.7	21.1
C	4.02	4.42
★D	19.9	20.3
E	2	2.3
★F	4.8	5.2
★G	2.3	2.5
H	TYP14.02	
I	TYP16.55	
J	3.5	3.7
K	TYP13.26	
★L	0.58	0.62
★M	1.15	1.25
★a	TYP10.872	

★为关键尺寸



MURS7560PL-B1-W5094HF

Disclaimer

The information presented in this document is for reference only. Yangzhou Yangjie Electronic Technology Co., Ltd. reserves the right to make changes without notice for the specification of the products displayed herein to improve reliability, function or design or otherwise.

The product listed herein is designed to be used with ordinary electronic equipment or devices, and not designed to be used with equipment or devices which require high level of reliability and the malfunction of which would directly endanger human life (such as medical instruments, transportation equipment, aerospace machinery, nuclear-reactor controllers, fuel controllers and other safety devices), Yangjie or anyone on its behalf, assumes no responsibility or liability for any damages resulting from such improper use of sale.

This publication supersedes & replaces all information previously supplied. For additional information, please visit our website [http:// www.21yangjie.com](http://www.21yangjie.com) , or consult your nearest Yangjie's sales office for further assistance.