

P-Channel Enhancement Mode Field Effect Transistor

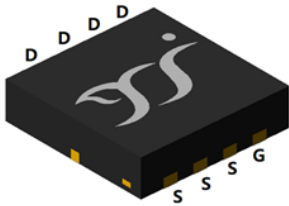

Top View

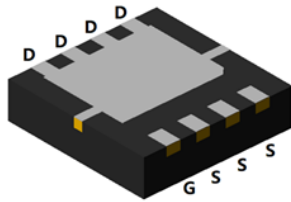

Bottom View

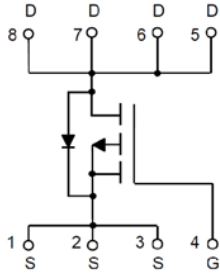

DFN3333-8L

Product Summary

- V_{DS} -100V
- I_D -16A
- $R_{DS(ON)}$ (at $V_{GS}=-10V$) <52m Ω
- 100% EAS Tested

General Description

- Excellent package for heat dissipation
- High density cell design for low $R_{DS(ON)}$
- Epoxy Meets UL 94 V-0 Flammability Rating
- Halogen Free

Applications

- Power switching application
- Uninterruptible power supply
- DC-DC convertor

Limiting Values

Parameter	Conditions		Symbol	Min	Max	Unit
Drain-source Voltage			V_{DS}	-	-100	V
Gate-source Voltage			V_{GS}	-25	25	
Continuous Drain Current (Note 1,2)	Steady-State	$T_A=25^\circ\text{C}, V_{GS}=-10\text{V}$	I_D	-	-4.3	A
		$T_A=100^\circ\text{C}, V_{GS}=-10\text{V}$		-	-2.7	
Continuous Drain Current (Note 1,3)	Steady-State	$T_C=25^\circ\text{C}, V_{GS}=-10\text{V}, \text{Chip limitation}$		-	-16	
		$T_C=100^\circ\text{C}, V_{GS}=-10\text{V}$		-	-10	
Pulsed Drain Current	$T_C=25^\circ\text{C}, t_p \leq 10\mu\text{s}$		I_{DM}	-	-64	
Maximum Body-Diode Continuous Current	$T_C=25^\circ\text{C}$		I_S		-16	
Avalanche energy (non-repetitive)	$T_J=25^\circ\text{C}, V_G=-10\text{V}, R_G=25\Omega, L=0.5\text{mH}, I_{AS}=-17\text{A}$		EAS	-	72.25	mJ
Total Power Dissipation (Note 1,2)	Steady-State	$T_A=25^\circ\text{C}$	P_D	-	1.8	W
		$T_A=100^\circ\text{C}$		-	0.7	
Total Power Dissipation (Note 1,3)	Steady-State	$T_C=25^\circ\text{C}$		-	25	
		$T_C=100^\circ\text{C}$		-	10	
Junction and Storage Temperature Range			T_J, T_{STG}	-55	150	$^\circ\text{C}$

Thermal Resistance

Parameter		Symbol	Typ	Max	Units
Thermal Resistance Junction-to-Ambient (Note 2)	Steady-State	$R_{\theta JA}$	-	70	$^\circ\text{C/W}$
Thermal Resistance Junction-to-Case	Steady-State	$R_{\theta JC}$	-	5	

Ordering Information (Example)

PREFERRED P/N	PACKING CODE	Marking	MINIMUM PACKAGE(pcs)	INNER BOX QUANTITY(pcs)	OUTER CARTON QUANTITY(pcs)	DELIVERY MODE
YJQ052GP10H	F1	052GP10H	5000	10000	100000	13" reel



YJQ052GP10H

■ Electrical Characteristics

Parameter	Symbol	Conditions	Min	Typ	Max	Units
Static Parameter						
Drain-Source Breakdown Voltage	BV_{DSS}	$V_{GS}=0V, I_D=-250\mu A, T_j=25^\circ C$	-100	-	-	V
Zero Gate Voltage Drain Current	I_{DSS}	$V_{DS}=-100V, V_{GS}=0V, T_j=25^\circ C$	-	-	-1	μA
		$V_{DS}=-100V, V_{GS}=0V, T_j=150^\circ C$	-	-	-100	
Gate-Source Leakage Current	I_{GSS}	$V_{GS}=\pm 25V, V_{DS}=0V, T_j=25^\circ C$	-	-	± 100	nA
Gate Threshold Voltage	$V_{GS(th)}$	$V_{DS}=V_{GS}, I_D=-250\mu A, T_j=25^\circ C$	-1.9	-2.7	-3.5	V
Static Drain-Source On-Resistance	$R_{DS(on)}$	$V_{GS}=-10V, I_D=-16A, T_j=25^\circ C$	-	42	52	m Ω
Diode Forward Voltage	V_{SD}	$I_S=16A, V_{GS}=0V, T_j=25^\circ C$	-	-0.93	-1.2	V
Gate Resistance	R_G	$f=1MHz, T_j=25^\circ C$	-	12	-	Ω
Dynamic Parameters						
Input Capacitance	C_{iss}	$V_{DS}=-50V, V_{GS}=0V, f=1MHz, T_j=25^\circ C$	-	860	-	μF
Output Capacitance	C_{oss}		-	217	-	
Reverse Transfer Capacitance	C_{rss}		-	6	-	
Switching Parameters						
Total Gate Charge	Q_g	$V_{GS}=-10V, V_{DS}=-50V, I_D=-16A, T_j=25^\circ C$	-	14.2	-	nC
Gate-Source Charge	Q_{gs}		-	3.6	-	
Gate-Drain Charge	Q_{gd}		-	3.7	-	
Reverse Recovery Charge	Q_{rr}	$I_F=-16A, di/dt=100A/\mu s, V_{GS}=0V, V_R=-50V, T_j=25^\circ C$	-	88	-	nC
Reverse Recovery Time	t_{rr}		-	43	-	ns
Turn-on Delay Time	$t_{D(on)}$	$V_{GS}=-10V, V_{DS}=-50V, I_D=-16A, R_{GEN}=3\Omega, T_j=25^\circ C$	-	8	-	ns
Turn-on Rise Time	t_r		-	27	-	
Turn-off Delay Time	$t_{D(off)}$		-	28	-	
Turn-off Fall Time	t_f		-	31	-	

Note:

1. The entire application environment impacts the thermal resistance values shown, they are not constants and are only valid for the particular conditions noted.
2. The value of $R_{\theta JA}$ is measured with the device mounted on the 40mm*40mm*1.1mm single layer FR-4 PCB board with 1 in² pad of 2oz. Copper, in the still air environment with $T_A=25^\circ C$. The maximum allowed junction temperature of 150 $^\circ C$. The value in any given application depends on the user's specific board design.
3. Thermal resistance from junction to soldering point (on the exposed drain pad).



Typical Electrical and Thermal Characteristics Diagrams

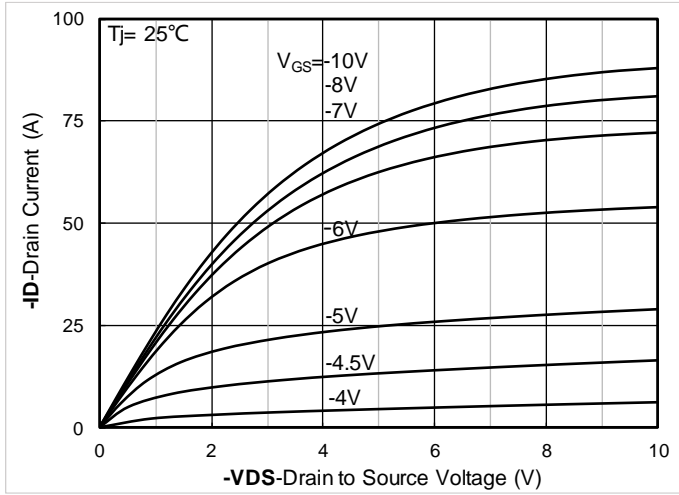

Figure 1. Output Characteristics; typical values

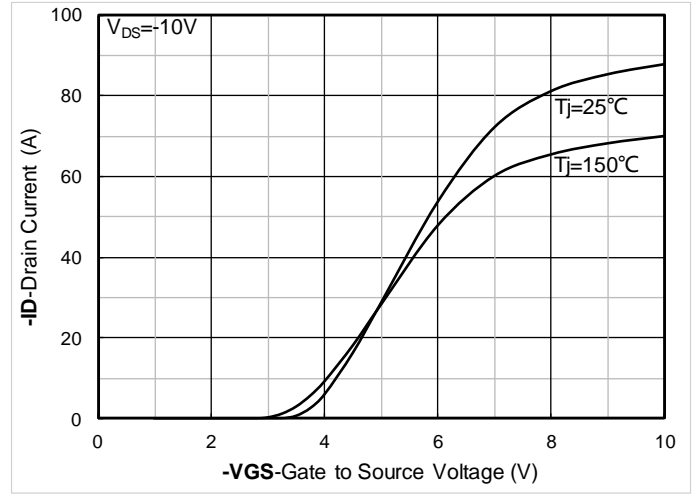

Figure 2. Transfer Characteristics; typical values

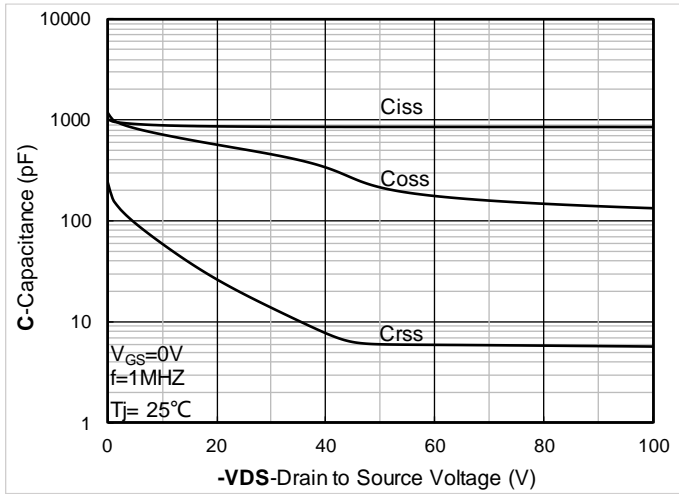

Figure 3. Capacitance Characteristics; typical values

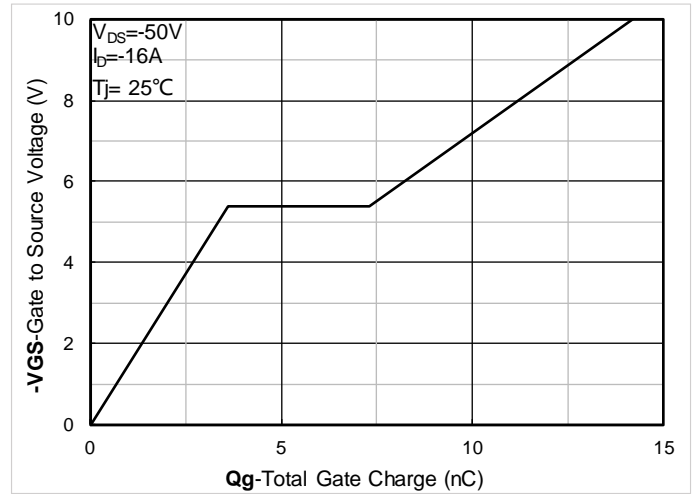

Figure 4. Gate Charge; typical values

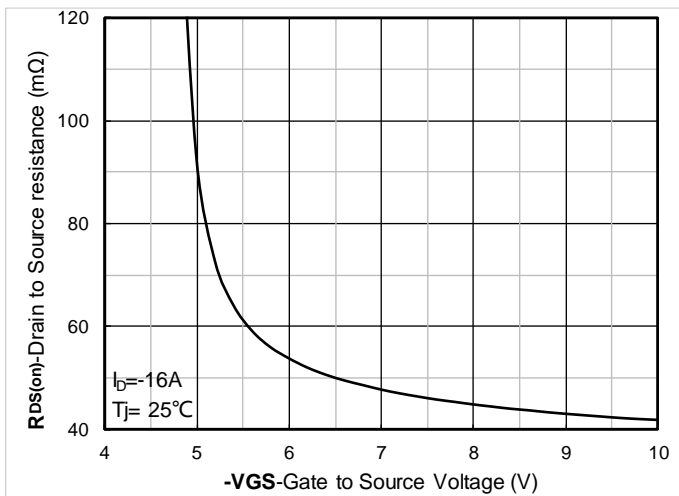

Figure 5. On-Resistance vs. Gate to Source Voltage; typical values

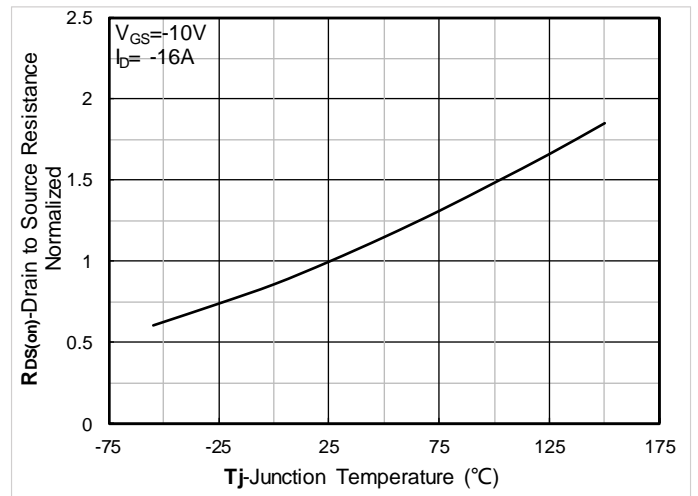

Figure 6. Normalized On-Resistance



YJQ052GP10H

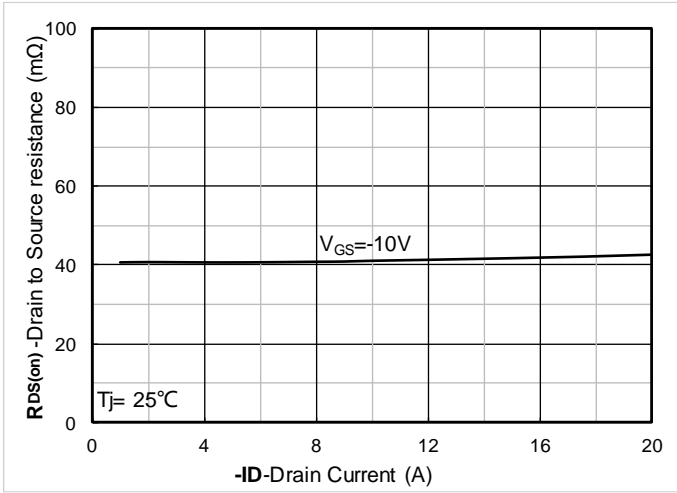

Figure 7. RDS(on) vs. Drain Current; typical values

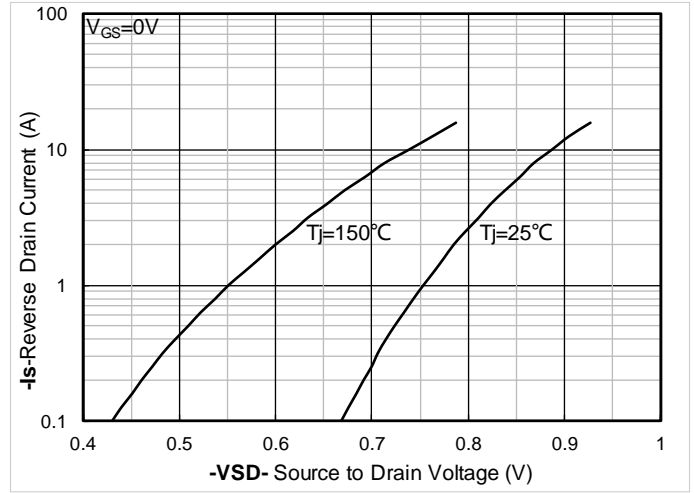

Figure 8. Forward characteristics of reverse diode; typical values

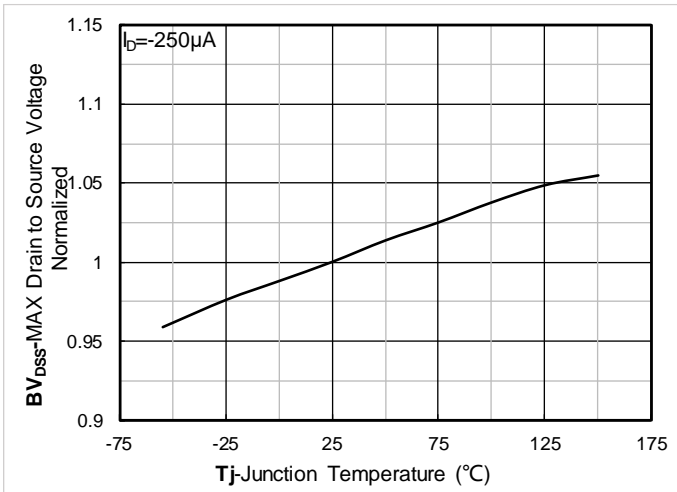

Figure 9. Normalized breakdown voltage

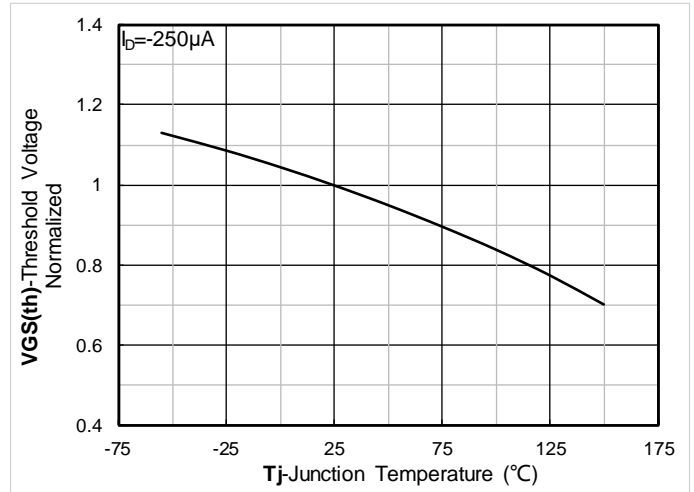

Figure 10. Normalized Threshold voltage

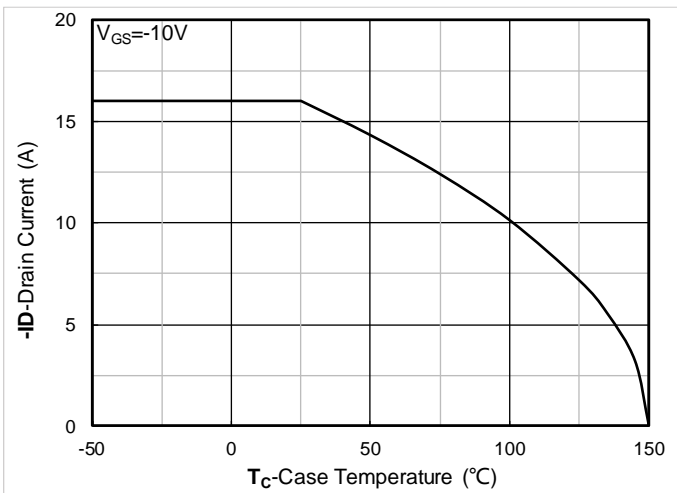

Figure 11. Current dissipation

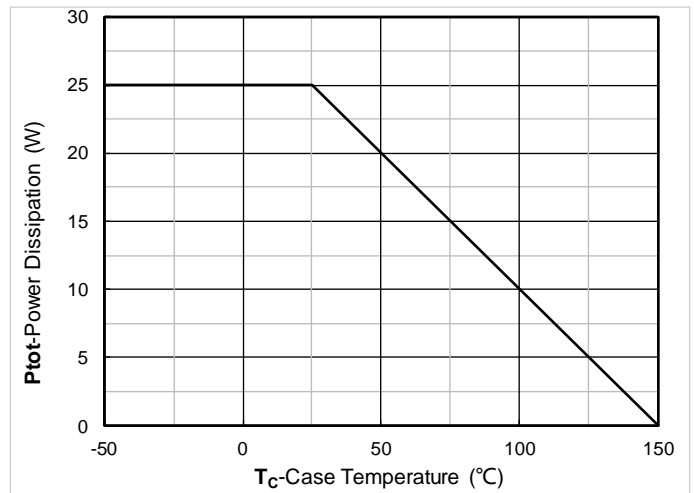

Figure 12. Power dissipation



YJQ052GP10H

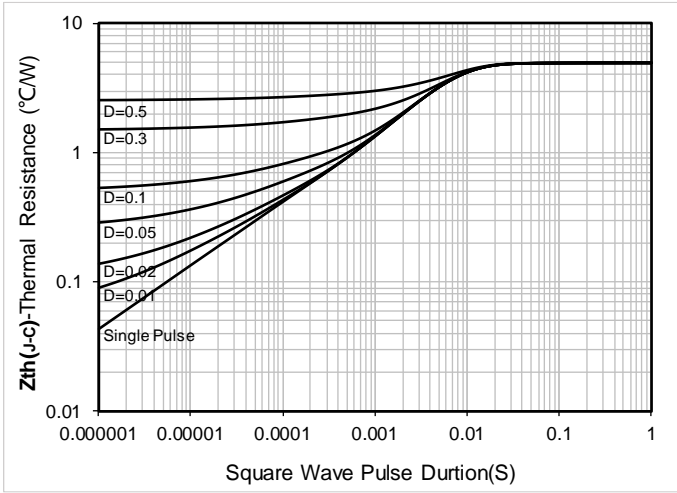

Figure 13. Maximum Transient Thermal Impedance

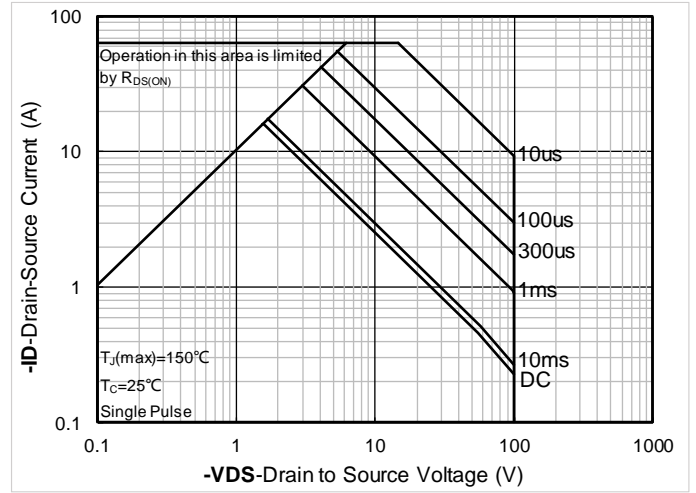
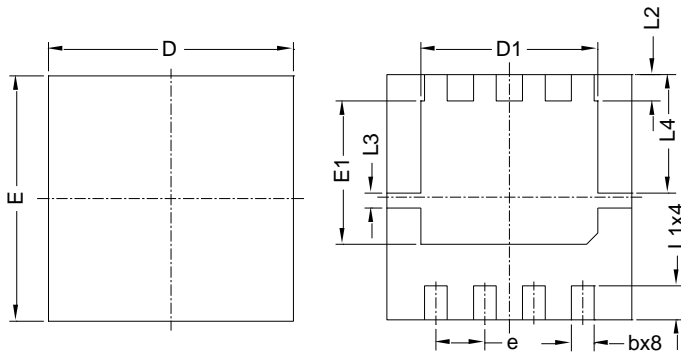

Figure 14. Safe Operation Area



YJQ052GP10H

■ DFN3333-8L-A-0.8MM Package information



Top View
正面视图

Bottom View
背面视图

SYMBOL	MILLIMETER		
	MIN	NOM	MAX
D	3.15	3.25	3.35
E	3.15	3.25	3.35
A	0.70	0.80	0.90
A1	0.20 BSC		
A2			0.10
D1	2.20	2.35	2.50
E1	1.80	1.90	2.00
L1	0.35	0.45	0.55
L2	0.35 BSC		
L3	0.20 BSC		
L4	1.57 BSC		
b	0.20	0.30	0.40
e	0.65 BSC		

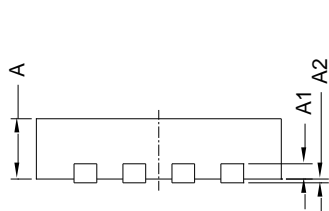

Side View
侧面视图

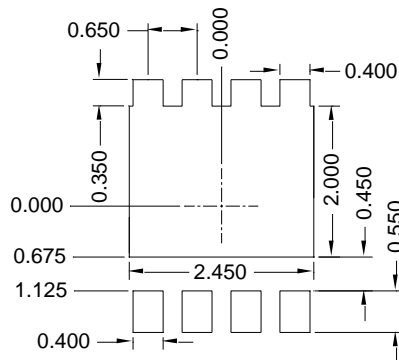

Suggested Solder Pad Layout
Top View

Note:

1. Controlling dimension: in millimeters.
2. General tolerance: ± 0.10 mm.
3. The pad layout is for reference purposes only.



YJQ052GP10H

Disclaimer

The information presented in this document is for reference only. Yangzhou Yangjie Electronic Technology Co., Ltd. reserves the right to make changes without notice for the specification of the products displayed herein to improve reliability, function or design or otherwise.

The product listed herein is designed to be used with ordinary electronic equipment or devices, and not designed to be used with equipment or devices which require high level of reliability and the malfunction of which would directly endanger human life (such as medical instruments, transportation equipment, aerospace machinery, nuclear-reactor controllers, fuel controllers and other safety devices), Yangjie or anyone on its behalf, assumes no responsibility or liability for any damages resulting from such improper use of sale.

This publication supersedes & replaces all information previously supplied. For additional information, please visit our website <http://www.21yangjie.com> , or consult your nearest Yangjie's sales office for further assistance.