

## Glass Passivated Rectifier Diode Modules



**VRRM** 800 to 1800V  
**IFAV** 100 A

### Applications

- Non-controllable rectifiers for AC/AC converters
- Line rectifiers for transistorized AC motor controllers
- Field supply for DC motors

### Features

- Blocking voltage: 800 to 1800V
- Heat transfer through aluminum oxide DBC ceramic isolated metal baseplate
- Glass passivated chip
- UL recognized applied for file no. E360040

### Circuit

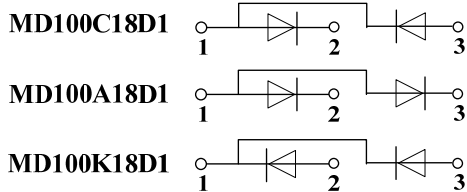

### Module Type

TYPE			VRRM	VRSM
MD100C08D1	MD100A08D1	MD100K08D1	800V	900V
MD100C12D1	MD100A12D1	MD100K12D1	1200V	1300V
MD100C16D1	MD100A16D1	MD100K16D1	1600V	1700V
MD100C18D1	MD100A18D1	MD100K18D1	1800V	1900V

### Maximum Ratings

Symbol	Conditions	Values	Units
IFAV	Single phase ,half wave 180° conduction Tc=109°C	100	A
IFSM	t=10mS Tvj =45°C	4000	A
i <sup>2</sup> t	t=10mS Tvj =45°C	80000	A <sup>2</sup> s
V <sub>isol</sub>	a.c.50HZ;r.m.s.;1min	3000	V
T <sub>vj</sub>		-40 to +150	°C
T <sub>stg</sub>		-40 to +125	°C
Mt	To terminals(M5)	3±15%	Nm
Ms	To heatsink(M6)	5±15%	Nm
Weight	Module (Approximately)	100	g

### Thermal Characteristics

Symbol	Conditions	Values	Units
R <sub>th(j-c)</sub>	Per diode	0.35	°C/W
R <sub>th(c-s)</sub>	Module	0.1	°C/W

### Electrical Characteristics

Symbol	Conditions	Values			Units
		Min.	Typ.	Max.	
V <sub>FM</sub>	T=25°C IF =300A	—	1.20	1.35	V
IRD	Tvj=150°C VRD=VRRM	—	—	5	mA



## Performance Curves

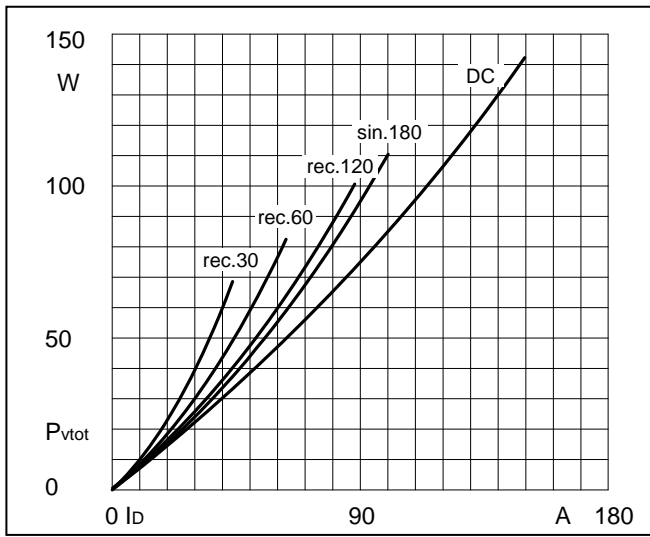

Fig1. Power dissipation

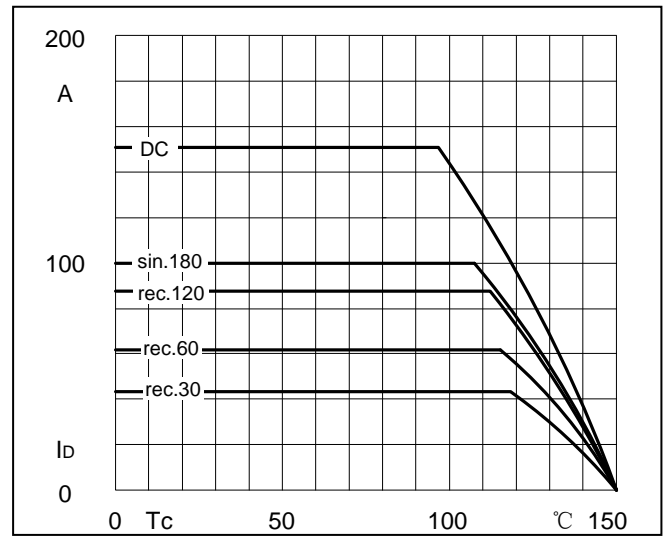

Fig2. Forward Current Derating Curve

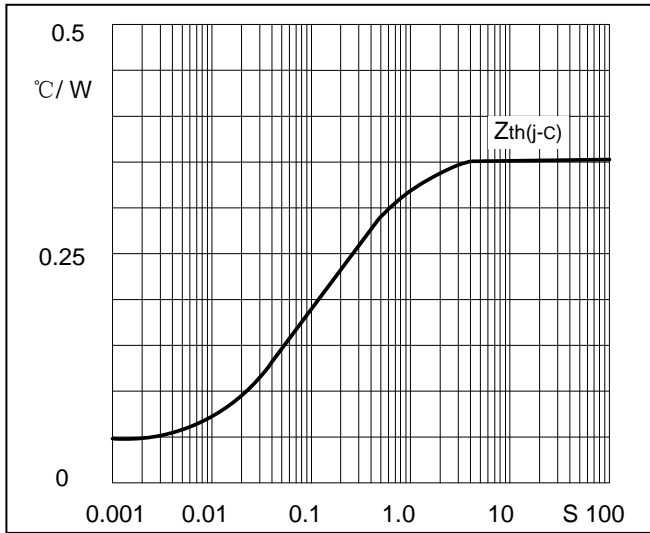

Fig3. Transient thermal impedance

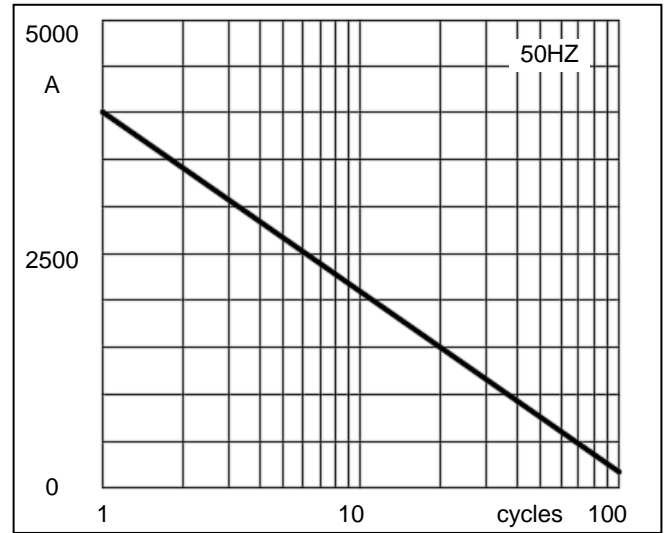

Fig4. Max Non-Repetitive Forward Surge Current

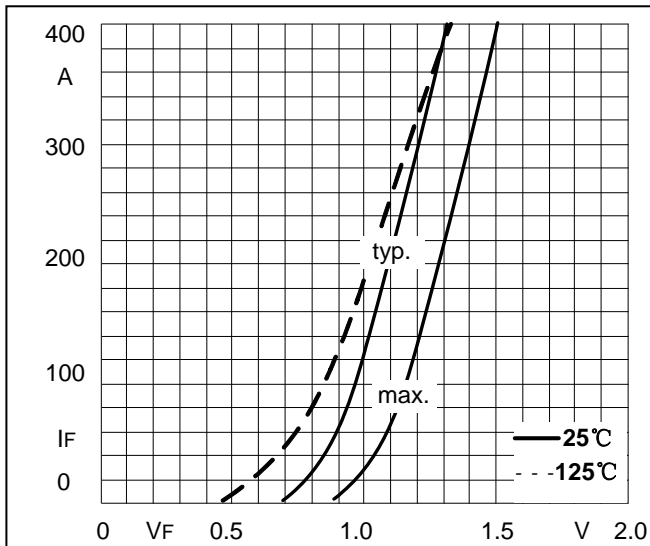
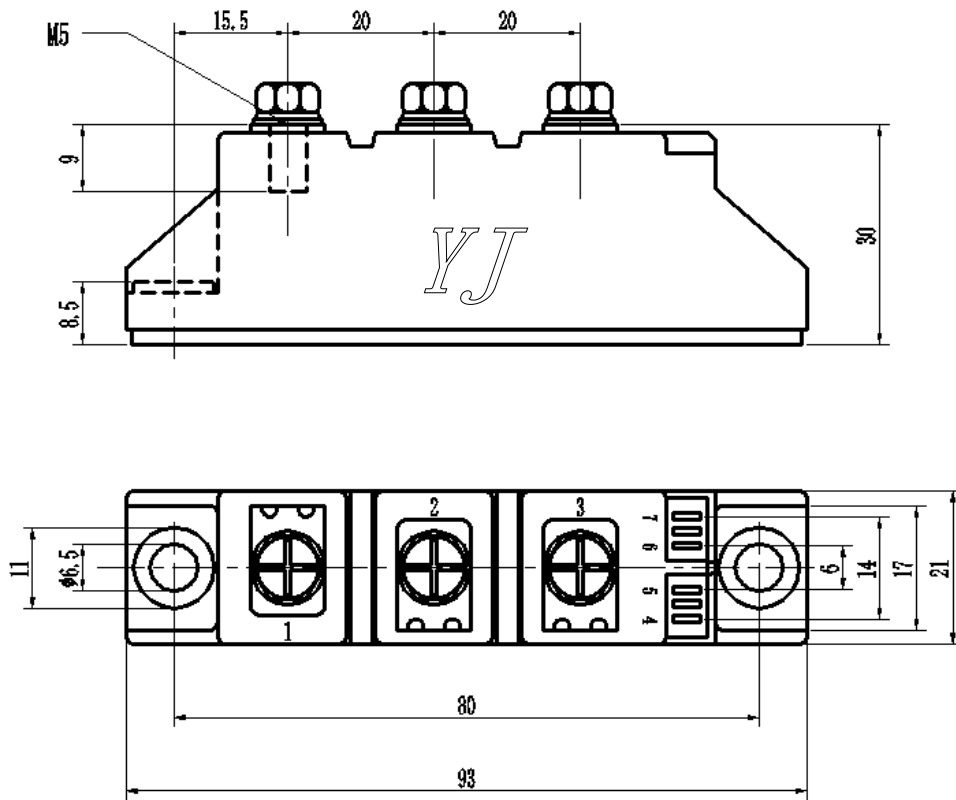

Fig5. Forward Characteristics

## Package Outline Information

CASE: D1



Dimensions in mm